



Grates & Drains

3monkeez[®]
innovate. create. deliver.



2023

3monkeez

www.3monkeez.com.au

sales@3monkeez.com.au

3monkeez[®]

MISSION STATEMENT

Put people first. Build a great product.
Reinvent industry expectations.

At 3monkeez, we understand that building a great quality and reliable product is only part of the story.

We provide an experience for our customers that exceeds expectations and makes us a trusted supplier of commercial plumbing and catering products across Australia. By putting people first our highly trained team can not only provide the right product and support, they also work closely with our customers to build long-lasting and rewarding relationships.

Through our commitment to manufacturing exceptional products and offering an unmatched experience for our customers we always strive to exceed and reinvent customer expectations when it comes to dealing with 3monkeez.

**GUARDIAN
TAPWARE**[®]



People are at the centre of everything we do. We provide industry leading customer service with a highly trained team of professionals available across Australia.



As a supplier of commercial stainless steel products for over 30 years the quality of our products matter to us. Our products will always provide creative and reliable solutions.



We are committed to providing innovative solutions that exceed customer expectations through our customer service, products, resources and unbeatable delivery times.

The Stainless Steel Advantage

Contents

In2Gr8 – V Bottom 50 Series	4	Floor Trough 2	17
In2Gr8 – V Bottom 75 Series	5	Floor Grate & Frame	18
In2Gr8 – V Bottom 100 Series	6	Floor Trough 4	19
In2Gr8 – V Bottom 125 Series	7	Floor Trough 5	20
In2Gr8 – V Bottom 150 Series	8	Smart Trough	21
In2Gr8 – Flat Bottom 75 Series	9	Floor Sump	22
In2Gr8 – Flat Bottom 100 Series	10	Grating Profiles	23
100mm Square Tile Insert Point Drain	11	Wedge Wire Grates to suit M-FT-7 and M-FT-8	25
130mm Square Tile Insert Point Drain	12	Wedge Wire G100	26
Stainless Steel Tile Insert Point Drain	13	Wedge Wire G200	27
130mm Wedge Wire Point Drain	15	Wedge Wire G300	28
Floor Trough 1	16	Dimpled Wedge Wire G300	29



Grates & Drains



In2Gr8 - V Bottom 50 Series

M-FT-7-050 (with G200 grate)

- Manufactured using 316 grade stainless steel
- Available in kit form or pre-fabricated to your requirement
- Kit form includes a hole saw and sealant
- 38mm outlet
- G200 wedge wire grate
- Corners available - 45 degree or 90 degree
- Joining strips available for continuous runs
- Typically used in showers, bathroom areas, balconies, courtyards and swimming pool areas
- Short lead times

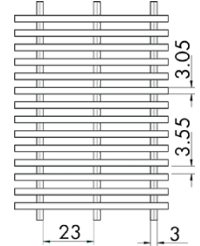
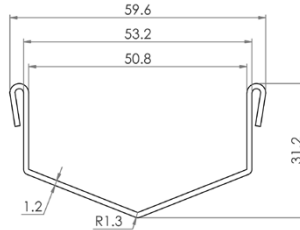

Channel



Grate



End Cap



Outlet



Joining Strip



Corner



Grates & Drains



In2Gr8 - V Bottom 75 Series

M-FT-7-075 (with G200 grate or tile insert)

- Manufactured using 316 grade stainless steel
- Available in kit form or pre-fabricated to your requirement
- Kit form includes a hole saw and sealant
- 38mm or 50mm outlet
- Either G200 wedge wire grate or tile insert
- Corners available - 45 degree or 90 degree
- Joining strips available for continuous runs
- Typically used in showers, bathroom areas, balconies, courtyards and swimming pool areas
- Short lead times

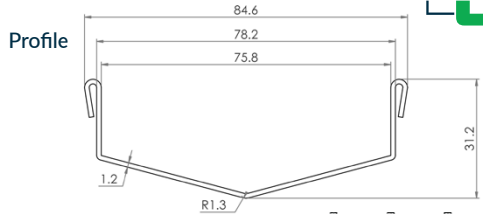

Channel

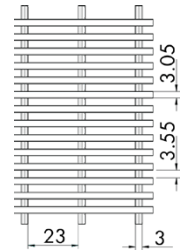

Grate



Tile Insert

Tray Depth
10.4mm



End Cap



Outlet



Joining Strip



Corner



Grates & Drains



In2Gr8 - V Bottom 100 Series

M-FT-7-100 (with G200 grate or tile insert)

- Manufactured using 316 grade stainless steel
- Available in kit form or pre-fabricated to your requirement
- Kit form includes a hole saw and sealant
- 38mm, 50mm, 76mm or 89mm outlet
- Optional fixed and removable strainer
- Either G200 wedge wire grate or tile insert
- Corners available - 45 degree or 90 degree
- Joining strips available for continuous runs
- Typically used in showers, bathroom areas, balconies, courtyards and swimming pool areas
- Short lead times



Profile

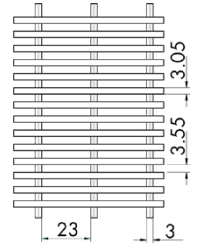
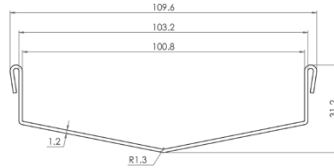

Channel



Grate



Tile Insert



Tray Depth
10.4mm

End Cap



Outlet



Fixed and Removable Strainers



Joining Strip



Corner



Grates & Drains



In2Gr8 - V Bottom 125 Series



M-FT-7-125 (with G300 grate)

- Manufactured using 316 grade stainless steel
- Available in kit form or pre-fabricated to your requirement
- Kit form includes a hole saw and sealant
- 89mm outlet
- Optional fixed and removable strainer
- G300 wedge wire grate
- Joining strips available for continuous runs
- Typically used in driveway areas, balconies, courtyards and swimming pool areas
- Short lead times

Profile

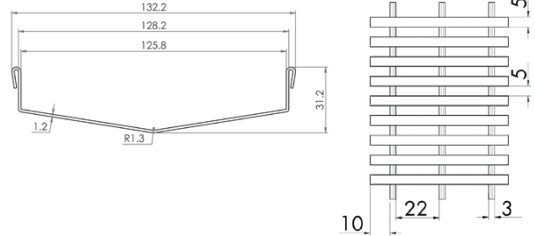

Channel



Grate



End Cap



Outlet



Fixed and Removable Strainers



Joining Strip



Grates & Drains



In2Gr8 - V Bottom 150 Series

M-FT-7-150 (with G300 grate)

- Manufactured using 316 grade stainless steel
- Available in kit form or pre-fabricated to your requirement
- Kit form includes a hole saw and sealant
- 89mm outlet
- Optional fixed and removable strainer
- G300 wedge wire grate
- Joining strips available for continuous runs
- Typically used in driveway areas, balconies, courtyards and swimming pool areas
- Short lead times



Profile

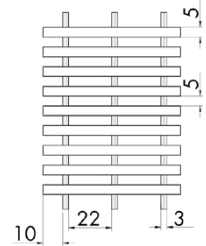
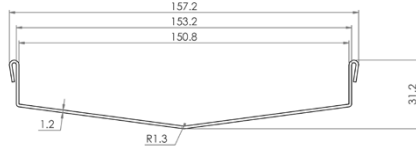

Channel



Grate



End Cap



Outlet



Fixed and Removable Strainers



Joining Strip



Grates & Drains



In2Gr8 - Flat Bottom 75 Series

M-FT-8-075 (with G200 grate or tile insert)

- Manufactured using 316 grade stainless steel
- Available in kit form or pre-fabricated to your requirement
- Kit form includes a hole saw and sealant
- 38mm or 50mm outlet
- Either G200 wedge wire grate or tile insert
- Corners available - 45 degree or 90 degree
- Joining strips available for continuous runs
- Typically used in showers, bathroom areas, balconies, courtyards and swimming pool areas
- Short lead times



Profile

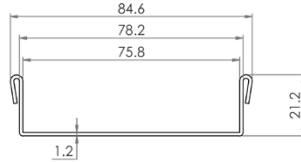

Channel

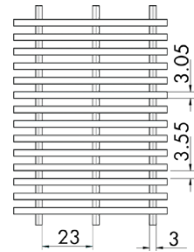

Grate



Tile Insert

Tray Depth
10.4mm

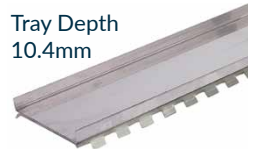

End Cap



Outlet



Joining Strip



Corner



Grates & Drains



In2Gr8 - Flat Bottom 100 Series

M-FT-8-100 (with G200 grate or tile insert)

- Manufactured using 316 grade stainless steel
- Available in kit form or pre-fabricated to your requirement
- Kit form includes a hole saw and sealant
- 38mm, 50mm, 76mm or 89mm outlet
- Optional fixed and removable strainer
- Either G200 wedge wire grate or tile insert
- Corners available - 45 degree or 90 degree
- Joining strips available for continuous runs
- Typically used in showers, bathroom areas, balconies, courtyards and swimming pool areas
- Short lead times



Profile

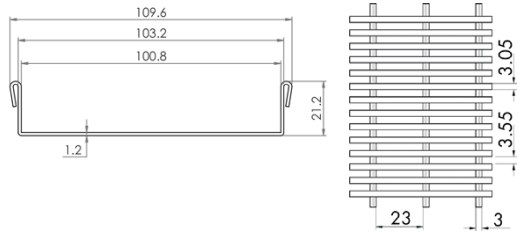

Channel



Grate



Tile Insert



Tray Depth
10.4mm

End Cap



Outlet



Fixed and Removable Strainers



Joining Strip



Corner



Grates & Drains



100mm Square Tile Insert Point Drain

FW-100TI-50 (50mm outlet)

- Slimline for easy installation
- Removable tray



Top

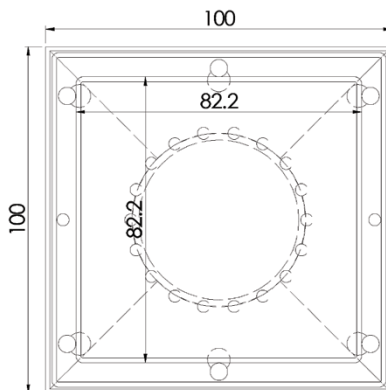

Front

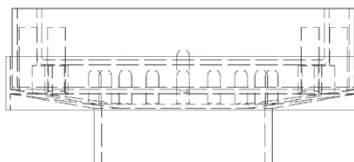

Cross Section

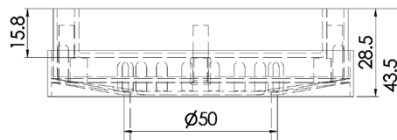

Grates & Drains



130mm Square Tile Insert Point Drain

FW-130TI (103.1mm outlet)

FW-130TI-80 (73.9mm outlet)

- Slimline for easy installation
- Removable tray



Top

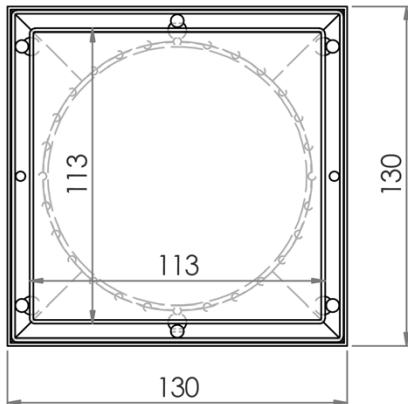

Front

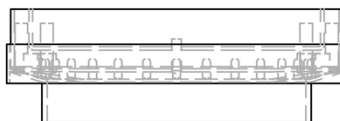

Cross Section

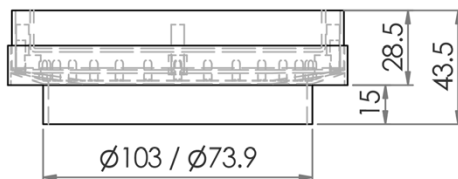

Grates & Drains



Stainless Steel Tile Insert Point Drains



FW-100STI

(100mm Square - 50mm Outlet)

- Slimline for easy installation
- 1.5mm 304 grade stainless steel
- Removable tray



Top

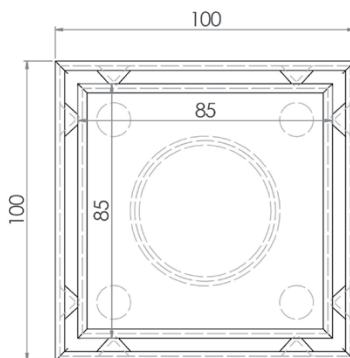

Front



Cross Section

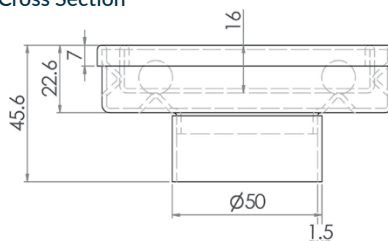

Grates & Drains



Stainless Steel Tile Insert Point Drains

FW-130STI

(130mm Square - 100mm Outlet)

FW-130STI-80

(130mm Square - 74mm Outlet)

- Slimline for easy installation
- 1.5mm 304 grade stainless steel
- Removable tray



Top

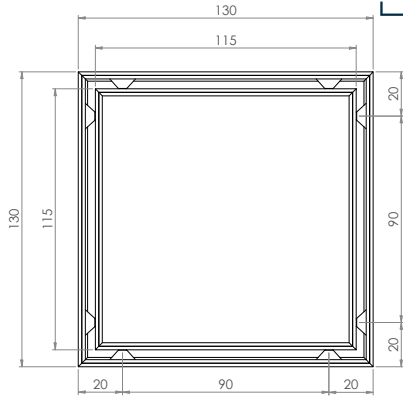

Front

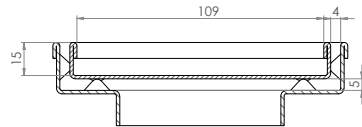

FW-130STI-80

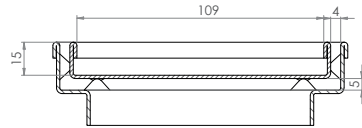

FW-130STI

Cross Section

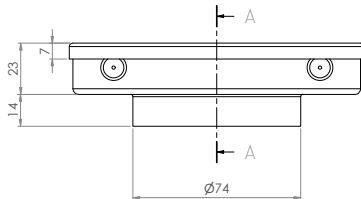

FW-130STI-80

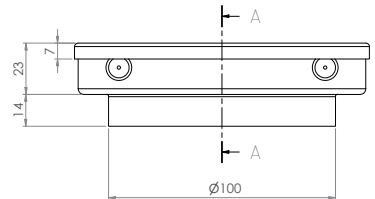

FW-130STI

Grates & Drains



130mm Wedge Wire Point Drain

FW-130WWI

- Slimline for easy installation
- Removable grate
- G200 profile grate
- 89mm spigot
- 316 grade stainless steel
- In stock and available for immediate delivery
- Custom sizes available on request - lead times apply



Top

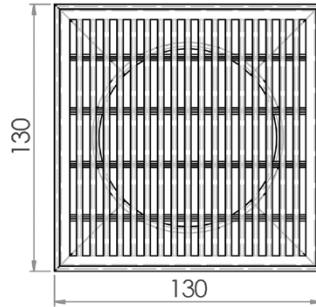

Front

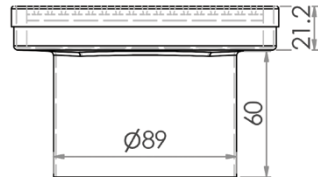

Side

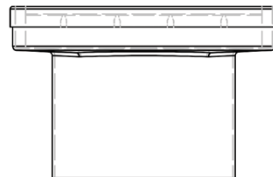

Grates & Drains



Floor Trough 1

M-FT-1

- Manufactured to required length and width, using a choice of either 304 or 316 grade stainless steel
- Optional fixed secondary strainer and removable strainer basket
- Size and position of the outlet is manufactured to the customer's requirements
- Typically used for commercial applications
- Manufactured with your choice of grating
- Loading as required
- Custom made product incurs a lead time

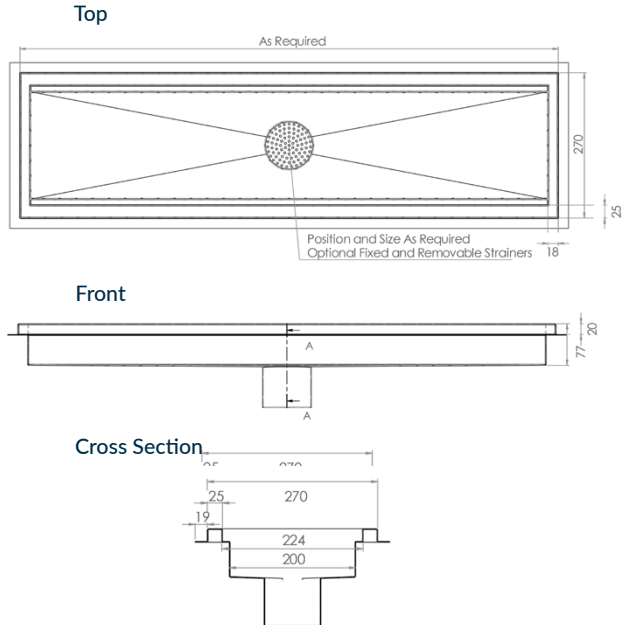

Slot Grate Angled



Slot Grate Straight



Square Bar

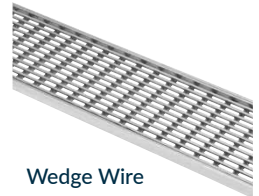

Wedge Wire

Grates & Drains



Floor Trough 2

M-FT-2

- Manufactured to required length and width, using a choice of either 304 or 316 grade stainless steel
- Optional fixed secondary strainer and removable strainer basket
- Size and position of the outlet is manufactured to the customer's requirements
- Typically used for commercial applications
- Manufactured with your choice of grating
- Loading as required
- Custom made product incurs a lead time

Top

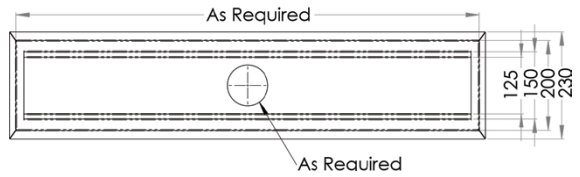

Front

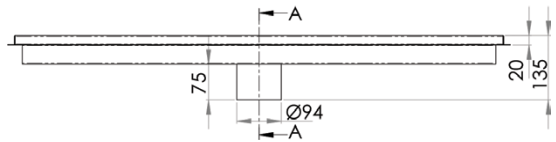

Cross Section

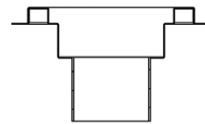

Slot Grate Angled



Slot Grate Straight



Square Bar

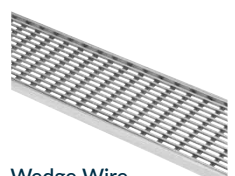

Wedge Wire

Grates & Drains



Floor Grate & Frame

M-FT-3

- Manufactured to required length and width, using a choice of either 304 or 316 grade stainless steel
- Ideal for both light and heavy duty applications
- Manufactured with your choice of grating
- Loading as required
- Custom made product incurs a lead time

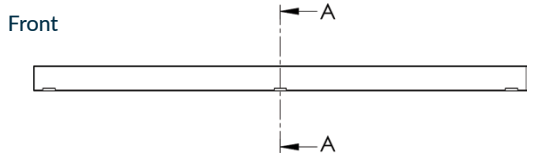
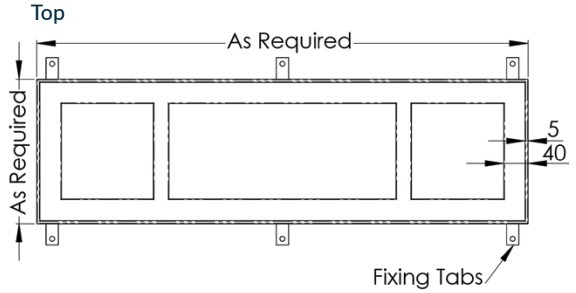

Cross Section

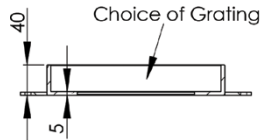

Slot Grate Angled



Slot Grate Straight



Square Bar

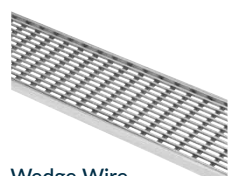

Wedge Wire

Grates & Drains



Floor Trough 4

M-FT-4

- Manufactured to required length and width, using a choice of either 304 or 316 grade stainless steel
- Optional fixed secondary strainer and removable strainer basket
- Size and position of the outlet is manufactured to the customer's requirements
- Typically used for commercial applications
- Manufactured with your choice of grating
- Loading as required
- Custom made product incurs a lead time

Top

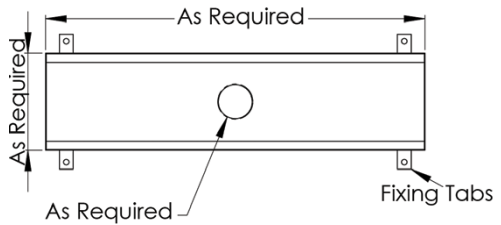

Front

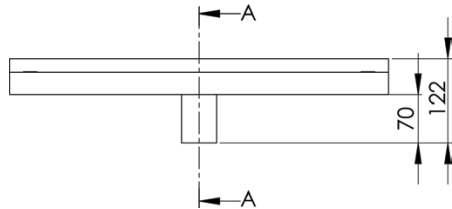

Cross Section

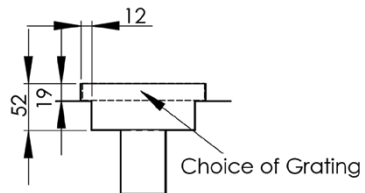

Slot Grate Angled



Slot Grate Straight



Square Bar

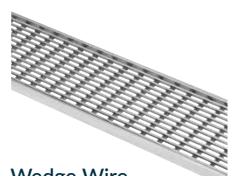

Wedge Wire

Grates & Drains



Floor Trough 5

M-FT-5

- Manufactured to required length and width, using a choice of either 304 or 316 grade stainless steel
- Size and position of outlet is manufactured to the customer's requirements
- Typically used in showers, bathrooms and balcony areas
- Manufactured with your choice of grating
- Loading as required
- Custom made product incurs a lead time

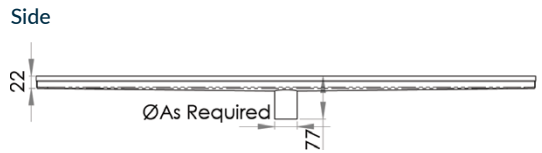
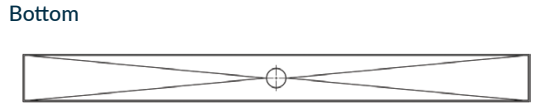
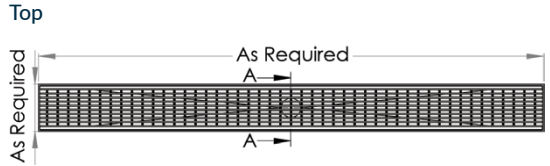

Cross Section

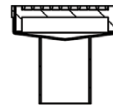

Slot Grate Angled



Slot Grate Straight



Square Bar



Wedge Wire

Grates & Drains



Smart Trough

M-FT-6

- Manufactured to required length and width, using a choice of either 304 or 316 grade stainless steel
- Size and position of outlet is manufactured to the customer's requirements
- Tile tray depth can be modified to your requirement
- Typically used in showers, bathrooms and tiled balcony areas
- Accepts a tile finish
- Custom made product incurs a lead time



Top

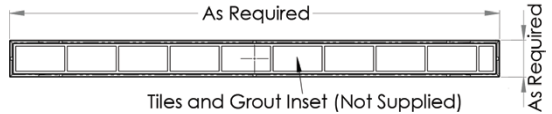

Front

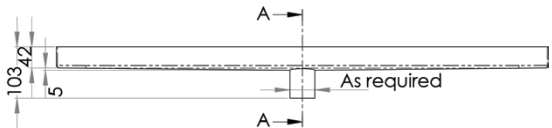

Bottom

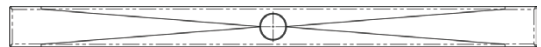

Cross Section

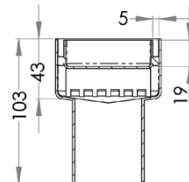

Grates & Drains



Floor Sump

M-FS-1

- Manufactured to required length and width, using a choice of either 304 or 316 grade stainless steel
- Optional fixed secondary strainer and removable strainer basket
- Typically used in commercial or industrial settings, as well as food preparation areas
- Manufactured with your choice of grating
- Loading as required
- Custom made product incurs a lead time

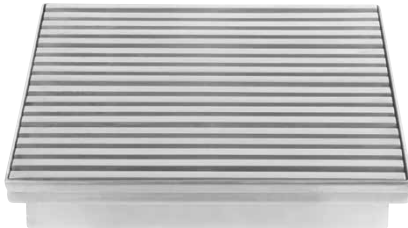

Top

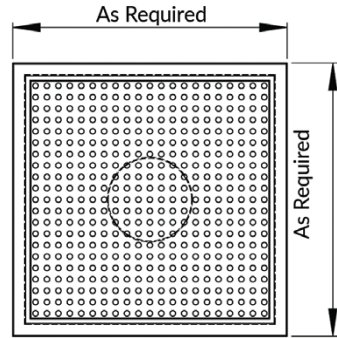

Front

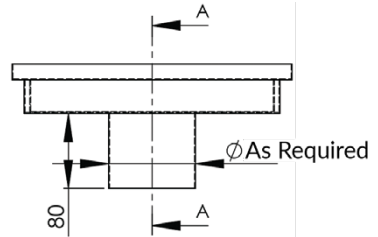

Cross Section

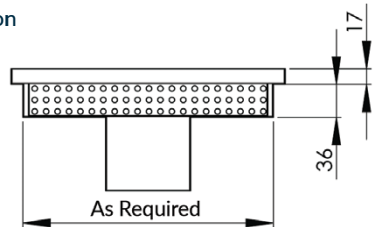

Slot Grate Angled



Slot Grate Straight



Square Bar

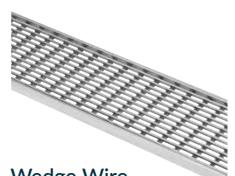

Wedge Wire

Grates & Drains



Grating Profiles

M-SBGO (*square bar*)

- Modern lineal design
- Robust
- Designed for domestic and commercial applications
- Manufactured to required length and width, using a choice of either 304 or 316 grade stainless steel
- Light to heavy duty
- Grate manufactured from 6mm or 10mm stainless steel square bar

M-SBGO



M-WWGO (*wedge wire*)

- Unique self-cleaning design
- Manufactured to required length and width, using a choice of either 304 or 316 grade stainless steel
- Aesthetically pleasing design
- Loading as required
- Three profiles available (WW-G100, WW-G200 and WW-G300)

M-WWGO



Grates & Drains



Grating Profiles

M-LCGO-SLOT

- Modern lineal design
- Robust
- Designed for domestic and commercial applications
- Manufactured to required length and width, using a choice of either 304 or 316 grade stainless steel
- Light to heavy duty
- Grate manufactured from 4mm or 10mm stainless steel laser cut

M-LCGO-SLOT



M-LCGO-ANGLED

- Modern lineal design
- Robust
- Designed for domestic and commercial applications
- Manufactured to required length and width, using a choice of either 304 or 316 grade stainless steel
- Light to heavy duty
- Grate manufactured from 4mm or 10mm stainless steel laser cut

M-LCGO-ANGLED



Grates & Drains



Wedge Wire Grates To Suit In2Gr8



- Manufactured using 316 grade stainless steel
- Lengths ranging from 900mm - 2400mm
- Typically used in showers, bathroom areas, balconies, courtyards and swimming pool areas

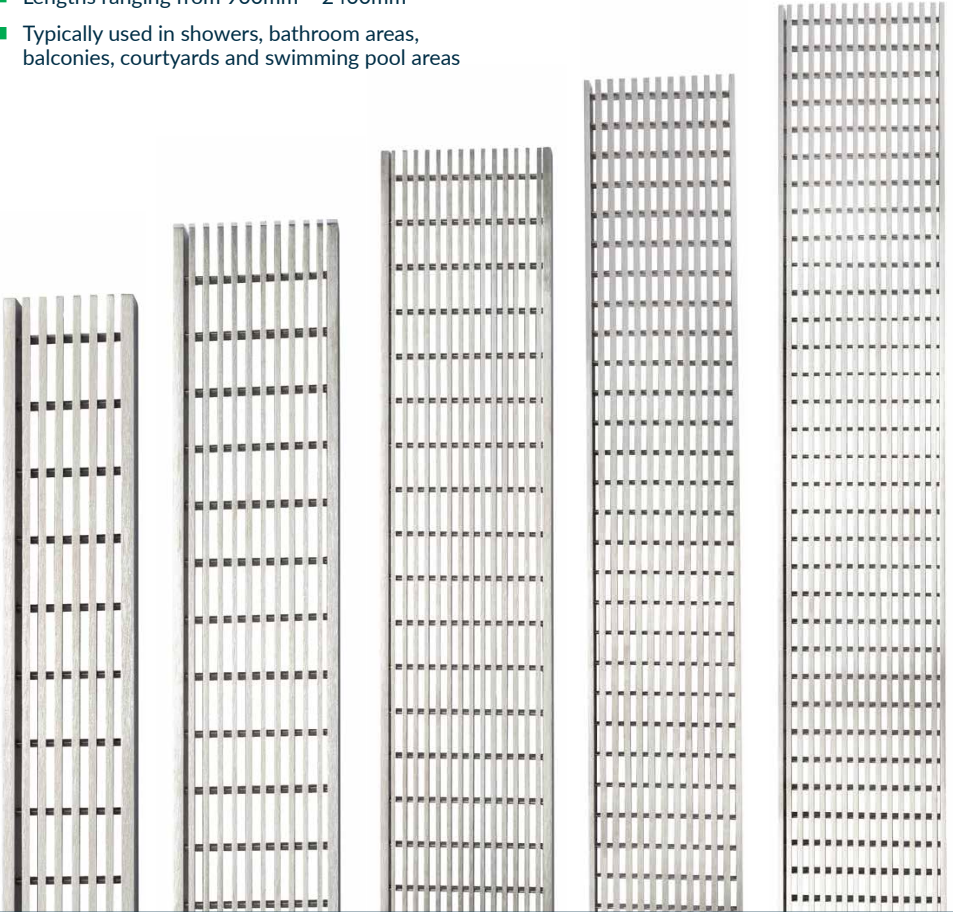

G200
50mm

G200
75mm

G200
100mm

G300
125mm

G300
150mm

Grates & Drains



Wedge Wire G100

WW-G100-304 (304 grade)

WW-G100-316 (316 grade)

- Wire Size
2.25mmW x 3.50mmH. Gap 5.00mm
- Support Bars
3.00mmW x 6.25mmH. Gap 16.00mm
- Convenient sheet size minimises wastage - 2400mm x 727mm
- 304 or 316 grade stainless steel
- Versatile and long lasting
- Flat bed manufacturing technique - not rolled
- Available off the shelf



Top

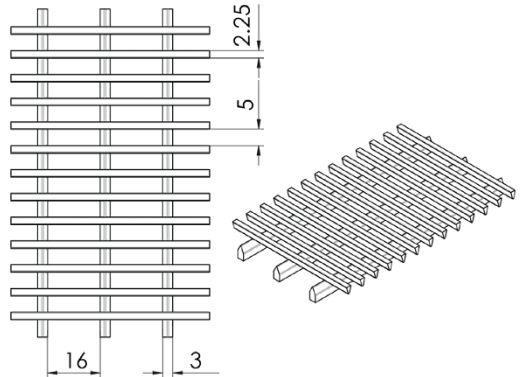

Side

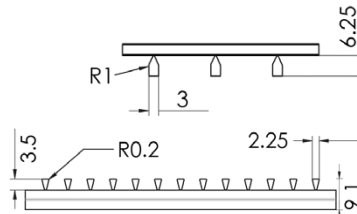

Bottom

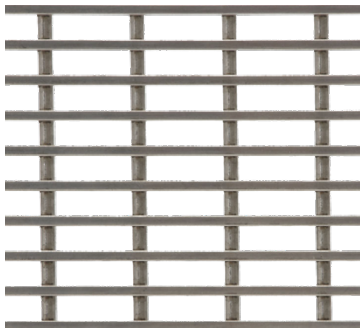
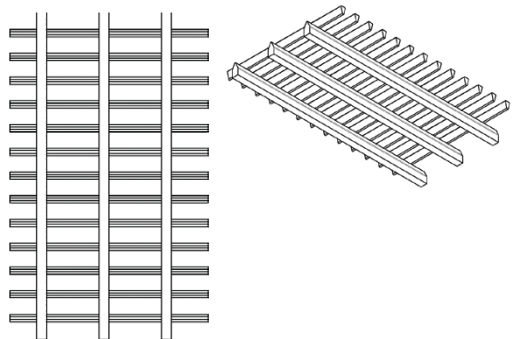

Grates & Drains



Wedge Wire G200

WW-G200-304 (304 grade)

WW-G200-316 (316 grade)

- Wire Size
3.05mmW x 4.25mmH. Gap 3.55mm
- Support Bars
3.00mmW x 6.25mmH. Gap 23.00mm
- Convenient sheet size minimises wastage - 2400mm x 727mm
- 304 or 316 grade stainless steel
- Versatile and long lasting
- Flat bed manufacturing technique - not rolled
- Available off the shelf



Top

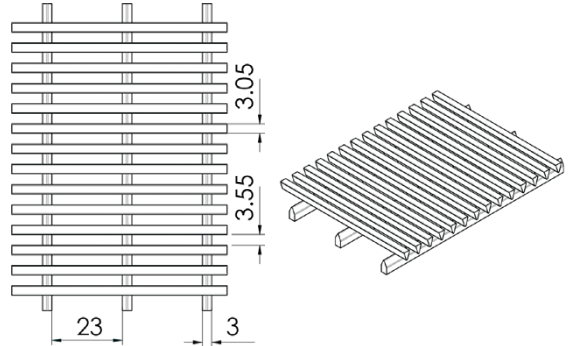

Side

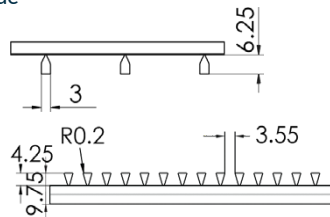

Bottom

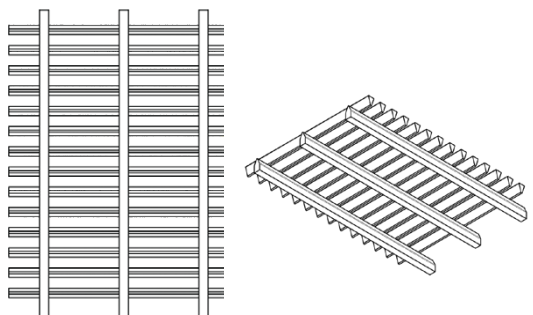

Grates & Drains



Wedge Wire G300

WW-G300-304 (304 grade)

WW-G300-316 (316 grade)

- Wire Size
5.00mmW x 5.00mmH. Gap 5.00mm
- Support Bars
3.00mmW x 12.00mmH. Gap 22.00mm
- Convenient sheet size minimises wastage - 1780mm x 727mm
- 304 or 316 grade stainless steel
- Versatile and long lasting
- Flat bed manufacturing technique - not rolled
- Available off the shelf

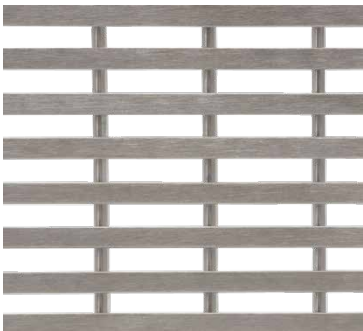
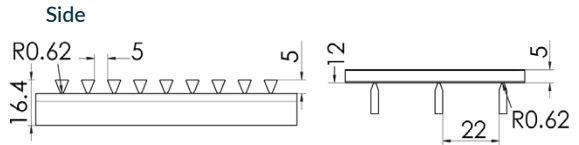
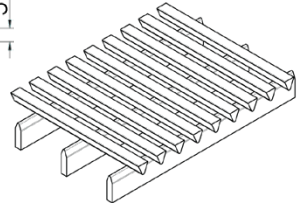
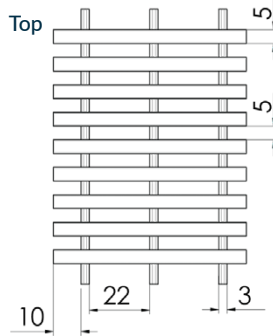

Bottom

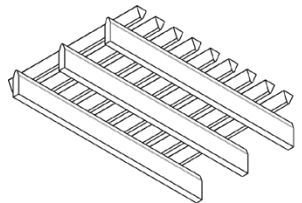
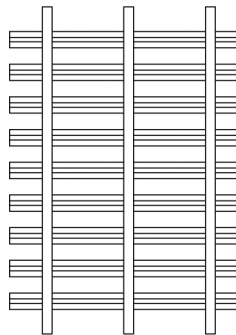

Grates & Drains



Dimpled Wedge Wire G300

WW-G300-DNS-304 (304 grade)

WW-G300-DNS-316 (316 grade)

- Dimple Non Slip Wedge Wire
- Wire Size 5.65mmW x 6.05mmH - 5.00mm Gap
- Support Bars 3mmW x 12.96mmH - 21mm Gap
- Sheet Size 2050mm x 1000mm
- 304 Grade S/S

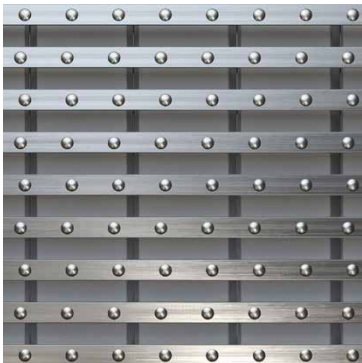
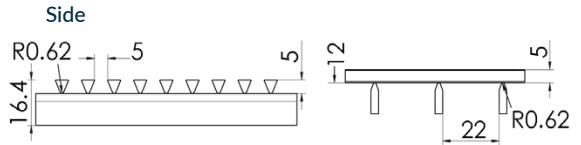
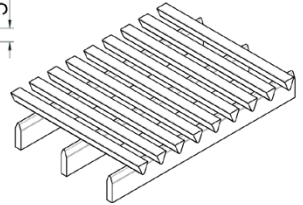
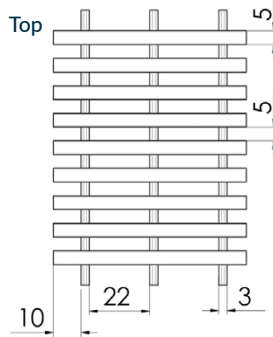

Bottom

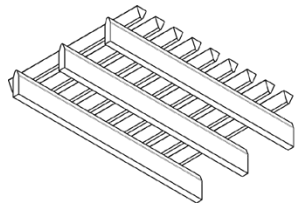
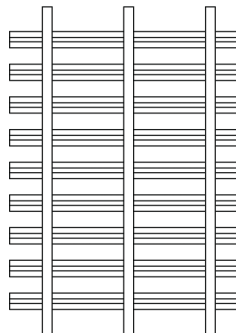



NSW 02 9627 6111

VIC 03 9357 6562

QLD 07 3881 0322

WA 08 6305 0681

SA 0417 731 718

ACT 0408 446 961

TAS 03 6344 7060

NT 0447 382 658

FNQ 07 4775 6956

3monkeez

www.3monkeez.com.au

sales@3monkeez.com.au